

SANYO

No.3490B

LM8560N, 8560B**Digital Alarm Clock****Overview**

Both the LM8560N and LM8560B are alarm equipped digital clock ICs with built-in drivers capable of directly driving LED display equipment. As ICs themselves, the V_{DD} pin for the LM8560N is graded to withstand a voltage of 15V while the LM8560B V_{DD} is graded for up to 17 V.

Applications

- Alarm clocks
- Clock-radios

Functions

- Current time display
- Snooze alarm function
- Sleep timer function (maximum intervals of 59 minutes or 1 hour and 59 minutes)

Features

- Single chip P-channel ED MOS LSI
- LED direct drive using time division (duplex configuration)
- Wide operating power supply voltage range
- Built-in alarm function with 24-hour control
- Supports changeover between 12-hour AM/PM and 24-hour displays
- Built-in battery backup CR oscillator
- Uses 50Hz or 60Hz as standard frequency
- Built-in automatic fast forward function for hour and minute settings
- Built-in sleep timer function (maximum intervals for 59 minutes or 1 hour and 59 minutes)
- Built-in snooze function supporting repeat use
- Equipped with power failure display function
- 900Hz output for alarm tone

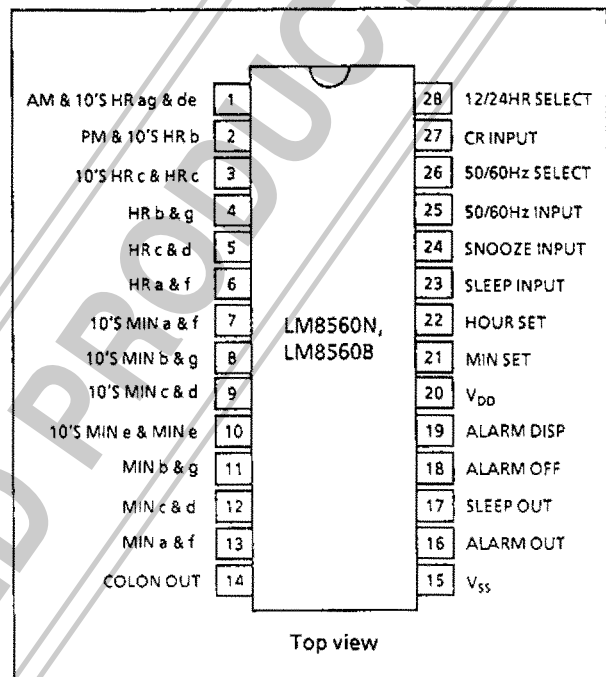
Pin Assignment**Package Dimensions**

unit : mm

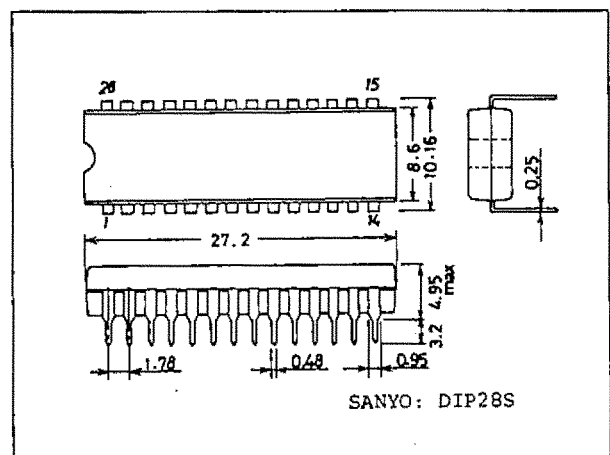
3029A-DIP28S

Description of Operations

- 50/60 Hz Input : Built-in Shumidt circuit enables noise elimination at 50/60Hz commercial frequencies with use of a simple CR filter. Built-in pull-up resistor.
- CR Input : When the AC power supply is interrupted, the time counter switches to a holding state and a built-in oscillator promptly begins operation. If 50/60Hz input continues for 3 clocks without arriving, this oscillator's output is activated and functions as the time counter clock in place of 50/60Hz input. The frequency level of this clock oscillator is determined according to the CR value. While the above mentioned oscillator is operating using backup mode, all segment output is switched to OFF.
(Note) When the backup oscillator is in use due to an AC power supply interruption, the 50/60Hz input pin must be maintained open or at a V_{SS} level.
- 50/60 Selective Input : When 50/60 selective input is connected to V_{SS} , 50Hz use is enabled. When 50/60 selective input is left open, V_{DD} is activated using an internal pull-down resistor and the setting is switched to enable use at 60Hz.
- Display Mode Selective Input (Alarm Select/ Sleep Select):
Since the pull-down resistor is built-in, selection from four display modes is possible using two SPST switches (single-pole and single-throw switches). Table 1 shows these display mode selections.

Table 1 Display Modes

Selective Input		Display Mode	Digt No. 1	Digt No. 2	Digt No. 3	Digt No.4
Alarm	Sleep					
NC	NC	Time display	10's place for hour, AM/PM	Hour	10's place for minute	Minute
V_{SS}	NC	Alarm display	10's place for hour, AM/PM	Hour	10's place for minute	Minute
NC	V_{SS}	Sleep display	Clear	Hour	10's place for minute	Minute
V_{SS}	V_{SS}	Second display	Clear	Minute	10's place for second	Second

Note: Activating V_{SS} using two inputs simultaneously (alarm select and sleep select), the display mode is switched to display seconds.

- Time Setting Input : There are two setting inputs for use with "hour" and "minute". Time content settings shown in Table 2 are possible by activating V_{SS} to these pins. A pull-down resistor is built-in.

Table 2 Setting Contents

Display Mode	Set Input	Functions
Time	HOUR	Immediately adds 1 to hour digits and then assigns an additional 1, at a speed of 2 Hz, after each 1/4 to 3/4 second.
	MIN	Immediately adds 1 to minute digits and then assigns an additional 1, at a speed of 2 Hz, after each 1/4 to 3/4 second.
	BOTH	Seconds are reset. Operates both as outline above.
Second (Alarm & Sleep)	HOUR (Note)	Second digits are cleared to [00].
	MIN	Time holds.
	BOTH*	Resets hour and minute digits as [0:00] when operating in 24-H mode or [12:00] when operating in 12-H mode.
Alarm	HOUR	Immediately adds 1 to hour digits and then assigns an additional 1, at a speed of 2 Hz, after each 1/4 to 3/4 second.
	MIN	Immediately adds 1 to minute digits and then assigns an additional 1, at a speed of 2 Hz, after each 1/4 to 3/4 second.
	BOTH	Resets hour and minute digits to [0:00] when operating in 24-hour mode or [12:00] when operating in 12-hour mode.
Sleep	—	Sets sleep counter to [0:59] instantly when V_{DD} is activated to sleep select.
	HOUR	Sets sleep counter to [1:59] instantly when V_{DD} is activated to sleep select and hour at the same time.
	MIN BOTH	Sleep counter loses 1 at a speed of 2 Hz. Sleep counter loses 1 at a speed of 2 Hz.

* Once conditions have been switched to reset or hold, input of other functions is locked until both HOUR and MIN input have been separated.

Note: When the digital reading for seconds is between 30 and 59 seconds, 1 is added to the digits for minutes as the digital reading for seconds resets to [00].

- 12/24H Select Input** : When this pin is set open (V_{DD}), a 12-hour display is enabled whereas connecting this pin to V_{SS} enables the 24-hour display. A pull-down resistor is build-in.
- Power Failure Detection Display** :
 When activated by drop in power supply, all segments which are lit begin to blink and the unit switches to a power failure detection display.
 The power failure detection display is canceled by activating V_{SS} to HOUR SET or MIN SET.
- Alarm Operation and Alarm Output** :
 The alarm signal outputs when alarm content matches the content of current time. When not reset by either snooze input or alarm off input, output continues after 1 hour and 59 minutes. This output signal consists of 900 Hz 2 Hz intermittent (50% duty) modulation signals. When the need arises, a filter can be applied to alter the alarm signal to a DC signal.
- Snooze Input** :
 When the alarm is sounding and instantly activating V_{SS} to this pin, alarm output is set to OFF for a period between 8 and 9 minutes after which time the alarm signal is once again output. The snooze function can be used repeatedly in 1 hour and 59 minutes intervals. A pull-down resistor is built-in. Activating V_{SS} to the snooze pin when the alarm is OFF resets the sleep timer counter to [0:00]. (This is known as the one-touch sleep timer reset function.)
- Alarm Off Input** :
 Activating this input pin to V_{SS} instantly sets alarm output to OFF. A pull-down resistor is built-in.
- Sleep Timer and Sleep Output** :
 Sleep output can turn on the radio and can be set for time intervals of 59 minutes or 1 hour and 59 minutes. Refer to Table 2 for the proper selection procedure (59 minutes or 1 hour and 59 minute selection). This sleep timer is constructed using a down counter and when the counter content arrives at [00], output is set to off and the radio turns off. Adding V_{SS} to snooze input turns sleep output off. When sleep output is on.

Block Diagram

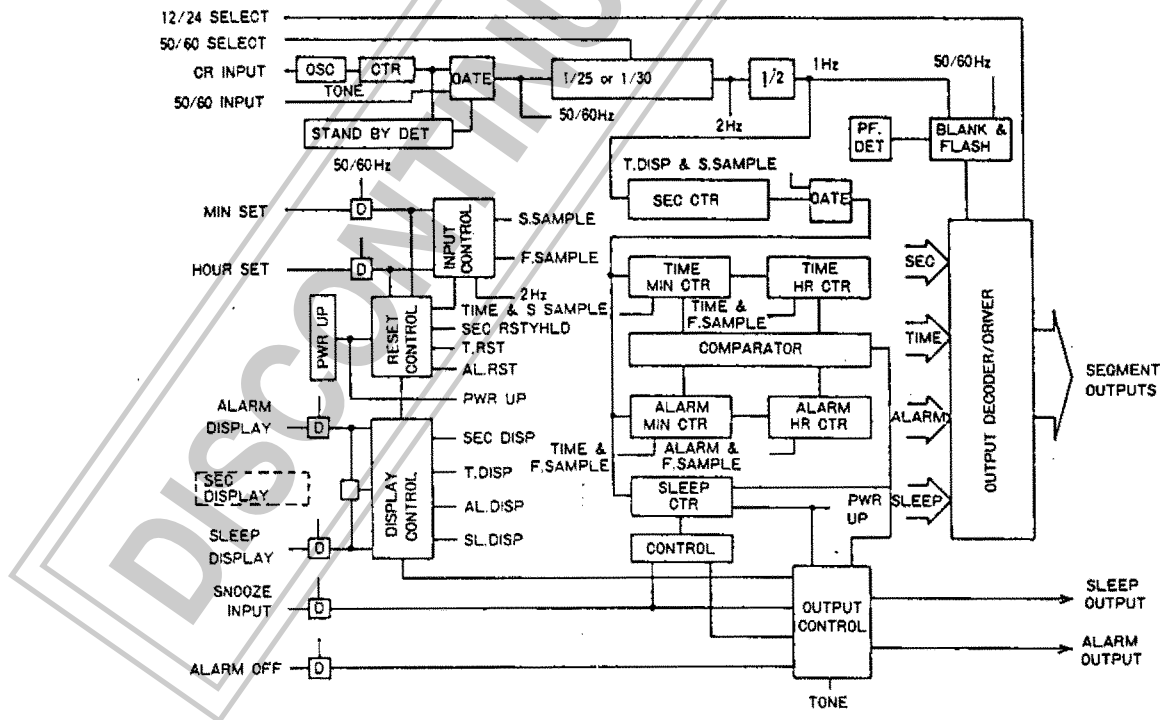

LM8560N, 8560B

Clock-radio Applied Circuit Diagram (+ power supply)

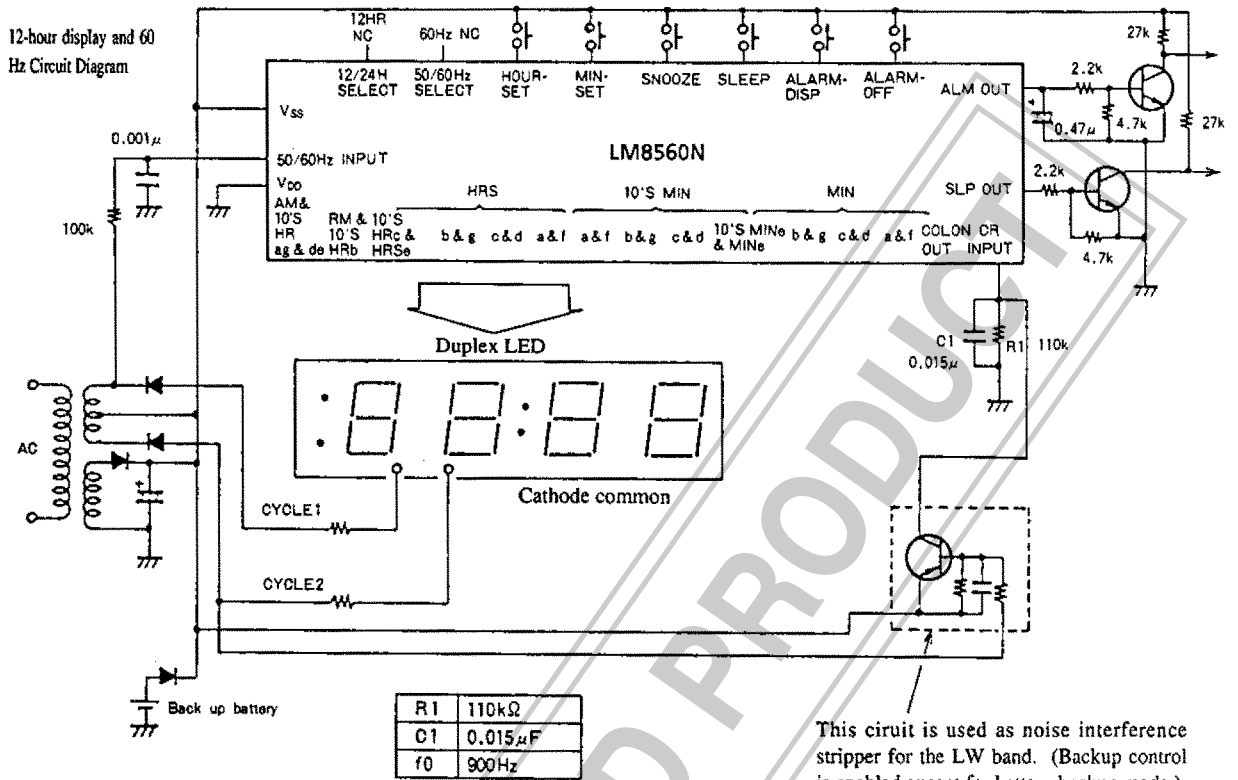

Clock Applied Circuit Diagram (- power supply)

Unit (resistance: Ω, capacitance: F)

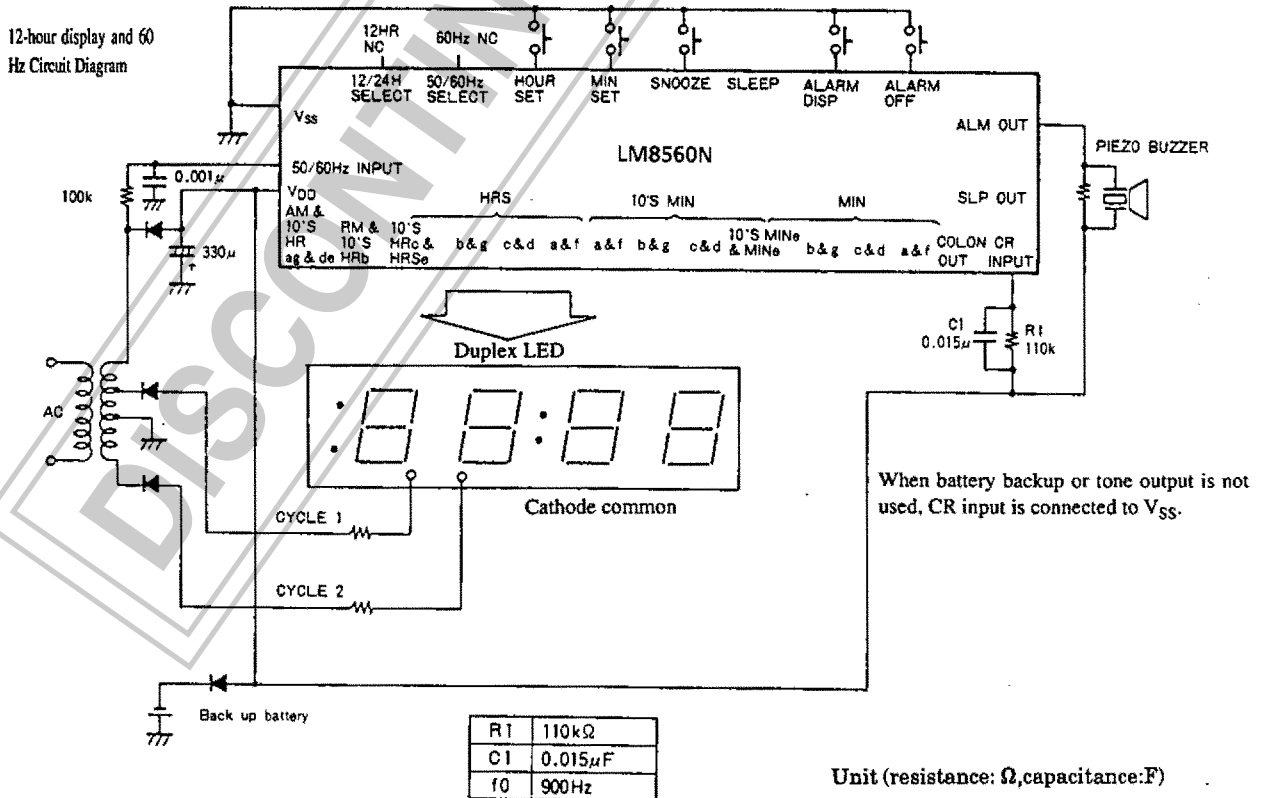

Unit (resistance: Ω, capacitance: F)

[LM8560N]

Specifications

Absolute Maximum Ratings at Ta = 25°C, VSS = 0V

				unit
Maximum supply voltage	V _{DD} max		-15.0 to +0.3	V
Input voltage (1)	V _{IN} (1)	50/60Hz INPUT	-15.0 to +0.3	V
Input voltage (2)	V _{IN} (2)	Except 50/60Hz INPUT	-15.0 to +0.3	V
Output voltage	V _{OUT}		-15.0 to +0.3	V
Input clamp current	I _{IN}	50/60Hz INPUT	-0.4 to +0.4	mA
Allowable power dissipation	Pd max	Ta = 70°C	0.7	W
Operating temperature	Topr		-30 to +70	°C
Storage temperature	Tstg		-55 to +125	°C

Allowable Operating Ranges at Ta = 25°C, VSS = 0V

			min	typ	max	unit
Supply voltage	V _{DD}		-14.0		-7.5	V
Input "H" level voltage (1)	V _{IH} (1)	50/60Hz INPUT	-1.0			V
Input "L" level voltage (1)	V _{IL} (1)	50/60Hz INPUT			V _{DD} +2	V
Input "H" level voltage (2)	V _{IH} (2)	Except 50/60Hz INPUT	-1.5			V
Input "L" level voltage (2)	V _{IL} (2)	Except 50/60Hz INPUT			V _{DD} +2	V
50/60Hz input pin input voltage	V _{AC-IN} (Note 1)	Sets V _{SS} as reference (Note 2)		V _{LED} (Note 1)		V

Electrical Characteristics at Ta = 25°C, VDD = -12V

			min	typ	max	unit
Input "H" level current (1)	I _{IH} (1)	50/60Hz INPUT, V _{IN} = V _{SS}			10	µA
Input "L" level current (1)	I _{IL} (1)	50/60Hz INPUT, V _{IN} = V _{DD}			10	µA
Input "H" level current (2)	I _{IH} (2)	Input pins other than 50/60 Hz input V _{IN} = V _{SS}			20	µA
Input "L" level current (2)	I _{IL} (2)	Input pins other than 50/60 Hz input V _{IN} = V _{DD}			10	µA
Output "H" level current (1)	I _{OH} (1)	Alarm output and sleep output V _{OH} = V _{SS} -1V	5			mA
Output leakage current (1)	I _{OF} (1)	Alarm output and sleep output V _{OUT} = V _{DD}			10	µA
Output "H" level current (2)	I _{OH} (2)	AM & 10'S HR ag & de (24Hmode), V _{OUT} = V _{DD} -1V	36			mA
Output leakage current (2)	I _{OF} (2)	AM & 10'S HR ag & de (24Hmode), V _{OUT} = V _{DD}			20	µA
Output "H" level current (3)	I _{OH} (3)	Segment output other than those listed above, V _{OUT} = V _{SS} -1V	18			mA
Output leakage current (3)	I _{OF} (3)	Segment output other than those listed above, V _{OUT} = V _{DD}			20	µA
Power failure detection voltage	V _{DD}		-7.5	-5.0		V
Consumption current	I _{CC}	Output set to off and pull-down attached input set open		5	7	mA
Backup oscillator stability factor	Fs	Standard value, 900Hz, V _{DD} = -9V±10%	-10		10	%
Backup oscillator accuracy	Fa	Standard value, 900Hz, V _{DD} = -9V	-10		10	%

[LM8560B]

Specifications

Absolute Maximum Ratings at Ta = 25°C, VSS = 0V

				unit
Maximum supply voltage	V _{DD} max		-17.0 to +0.3	V
Input voltage (1)	V _{IN} (1)	50/60Hz INPUT	-17.0 to +0.3	V
Input voltage (2)	V _{IN} (2)	50/60Hz INPUT	-17.0 to +0.3	V
Output voltage	V _{OUT}		-17.0 to +0.3	V
Input clamp current	I _{IN}	50/60Hz INPUT	-0.4 to +0.4	mA
Allowable power dissipation	Pd max	Ta = 70°C	0.7	W
Operating temperature	Topr		-30 to +70	°C
Storage temperature	Tstg		-55 to +125	°C

Allowable Operating Ranges at Ta = 25°C, VSS = 0V

			min	typ	max	unit
Supply voltage	V _{DD}		-14.0		-6.5	V
Input "H" level voltage (1)	V _{IH} (1)	50/60Hz INPUT	-1.0			V
Input "L" level voltage (1)	V _{IL} (1)	50/60Hz INPUT, V _{DD} ≤ -8V			V _{DD} + 2	V
		50/60Hz INPUT, V _{DD} > -8V			V _{DD} + 1	V
Input "H" level voltage (2)	V _{IH} (2)	Except 50/60Hz INPUT, V _{DD} ≤ -8V	-1.5			V
		Except 50/60Hz INPUT, V _{DD} > -8V	-1.0			V
Input "L" level voltage (2)	V _{IL} (2)	Except 50/60Hz INPUT, V _{DD} ≤ -8V			V _{DD} + 2	V
		Except 50/60Hz INPUT, V _{DD} > -8V			V _{DD} + 1	V
50/60Hz input pin input voltage	V _{AC-IN} (Note 1)	Sets V _{SS} as reference (Note 2)		V _{LED} (Note 1)		V

Electrical Characteristics at Ta = 25°C, VDD = -12V

			min	typ	max	unit
Input "H" level current (1)	I _{IH} (1)	50/60Hz INPUT, V _{IN} = V _{SS}			2	μA
Input "L" level current (1)	I _{IL} (1)	50/60Hz INPUT, V _{IN} = V _{DD}			10	μA
Input "H" level current (2)	I _{IH} (2)	Input pins other than 50/60 Hz input V _{IN} = V _{SS}			20	μA
Input "L" level current (2)	I _{IL} (2)	Input pins other than 50/60 Hz input V _{IN} = V _{DD}			2	μA
Output "H" level current (1)	I _{OH} (1)	Alarm output and sleep output V _{OH} = V _{SS} - 1V	5			mA
Output leakage current (1)	I _{OF} (1)	Alarm output and sleep output V _{OUT} = V _{DD}			10	μA
Output "H" level current (2)	I _{OH} (2)	AM & 10'S HR ag & de (24Hmode), V _{OUT} = V _{SS} - 1V	36			mA
Output leakage current (2)	I _{OF} (2)	AM & 10'S HR ag & de (24Hmode), V _{OUT} = V _{DD}			20	μA
Output "H" level current (3)	I _{OH} (3)	Segment output other than those listed above, V _{OUT} = V _{SS} - 1V	18			mA
Output leakage current (3)	I _{OF} (3)	Segment output other than those listed above, V _{OUT} = V _{DD}			20	μA
Power failure detection voltage	V _{DD}		-6.5	-5.0		V
Consumption current	I _{CC}	Output set to off and pull-down attached input set open		5	7	mA
Backup oscillator stability factor	F _s	Standard value, 900Hz, V _{DD} = -9V ± 10%	-10		10	%
Backup oscillator accuracy	F _a	Standard value, 900Hz, V _{DD} = -9V	-10		10	%

(Note 1)

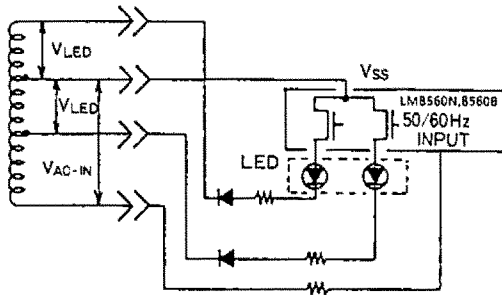

(Note 2)

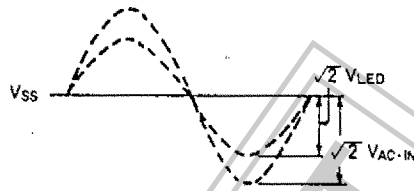

[Fig. 2]

V_{AC-IN} represents the average value for input voltage of the 50/60 Hz input pin.

V_{LED} represents the average value for power supply voltage for LED usage.

The above values represent those gained under no-load conditions.

[Fig. 1]

- No products described or contained herein are intended for use in surgical implants, life-support systems, aerospace equipment, nuclear power control systems, vehicles, disaster/crime-prevention equipment and the like, the failure of which may directly or indirectly cause injury, death or property loss.
- Anyone purchasing any products described or contained herein for an above-mentioned use shall:
 - ① Accept full responsibility and indemnify and defend SANYO ELECTRIC CO., LTD., its affiliates, subsidiaries and distributors and all their officers and employees, jointly and severally, against any and all claims and litigation and all damages, cost and expenses associated with such use:
 - ② Not impose any responsibility for any fault or negligence which may be cited in any such claim or litigation on SANYO ELECTRIC CO., LTD., its affiliates, subsidiaries and distributors or any of their officers and employees jointly or severally.
- Information (including circuit diagrams and circuit parameters) herein is for example only; it is not guaranteed for volume production. SANYO believes information herein is accurate and reliable, but no guarantees are made or implied regarding its use or any infringements of intellectual property rights or other rights of third parties.

This catalog provides information as of December, 1995. Specifications and information herein are subject to change without notice.